

Sistema de puertas plegables
Folding doors system
Système de portes coulissantes
Sistema de portas plegables

LITE FOLD

Interiorismo Madera
Interior Design Wood
Décoration d'Intérieur Bois
Interiorismo Fusta





LITE FOLD

ESP

LITE FOLD es un sistema para puertas plegables interiores diseñado para 2, 3, 4 ó 5 paneles plegables. Ofrece una máxima integración del perfil en el falso techo en su versión empotrada.

- Perfil Top empotrable para instalaciones invisibles.
- Funcionamiento óptimo gracias al sistema de pivotación.
- Instalación vista a techo o empotrada en falso techo.
- Perfilera inferior de dimensiones muy reducidas.
- Sistema Retrac: facilita el montaje del conjunto.
- Perfil de aluminio anodizado Silver.
- 5 paneles como máximo, con un total de 100 Kg.
- Espesor de paneles de 30 a 40 mm.
- Compatible con bisagras invisibles estándares.
- Garantía KLEIN® 5 años.

FRA

LITE FOLD est un système pour portes pliantes intérieures conçu pour 2, 3, 4 ou 5 vantaux pliants. Dans sa version encastrée, il offre une intégration maximale du profil dans le faux plafond.

- Profil Top encastrable pour installations invisibles.
- Fonctionnement optimal grâce au système de pivotement.
- Pose apparente à plafond ou encastrée à faux plafond.
- Rail inférieur de dimensions réduites.
- Système Retrac: facilite le montage de l'ensemble.
- Profil en aluminium anodisé Silver.
- 5 panneaux, au maximum, avec un poids total de 100 Kg.
- Épaisseur des panneaux de 30 à 40 mm.
- Compatible avec des charnières invisibles standards.
- Garantie KLEIN® 5 ans.

PESO TOTAL DE LAS HOJAS 100 kg
TOTAL WEIGHT OF THE LEAVES 220 lbs

2 HOJAS
2 LEAVES

50 kg 110 lbs	50 kg 110 lbs
------------------	------------------

3 HOJAS
3 LEAVES

33 kg 72 lbs	33 kg 72 lbs	33 kg 72 lbs
-----------------	-----------------	-----------------

4 HOJAS
4 LEAVES

25 kg 55 lbs	25 kg 55 lbs	25 kg 55 lbs	25 kg 55 lbs
-----------------	-----------------	-----------------	-----------------

5 HOJAS
5 LEAVES

20 kg 44 lbs	20 kg 44 lbs	20 kg 44 lbs	20 kg 44 lbs	20 kg 44 lbs
-----------------	-----------------	-----------------	-----------------	-----------------

ENG

LITE FOLD is an interior folding door system designed to fit in recessed openings through 2, 3, 4 or 5 folding panels. It guarantees maximum integration into the silhouette of false ceilings.

- Embeddable contoured track Top for invisible installations.
- Optimum functionality through pivot system.
- Visible and false ceiling installations.
- Reduced dimension lower profile.
- Retrac system facilitates the installation of the set.
- Anodized silver aluminum surface.
- Up to 5 panels, maximum of 100 Kg in total.
- Panels between 30 and 40 mm thick.
- Compatible with standard invisible hinges.
- Five-year KLEIN® warranty.

CAT

LITE FOLD és un sistema per a portes plegables interiors dissenyat per a 2, 3, 4 o 5 panells plegables. Ofereix una integració total del perfil al sostre fals en la versió encastada.

- Perfil Top encastable per a instal·lacions invisibles.
- Funcionament òptim gràcies al sistema de pivotació.
- Instal·lació vista al sostre o encastada al sostre fals.
- Perfilera inferior de dimensions molt reduïdes.
- Sistema Retrac: facilita el muntatge del conjunt.
- Perfil d'alumini anoditzat Silver.
- 5 panells com a màxim, amb un total de 100 Kg.
- Gruix dels panells de 30 a 40 mm.
- Compatible amb frontisses invisibles estàndards.
- Garantia KLEIN® de 5 anys.

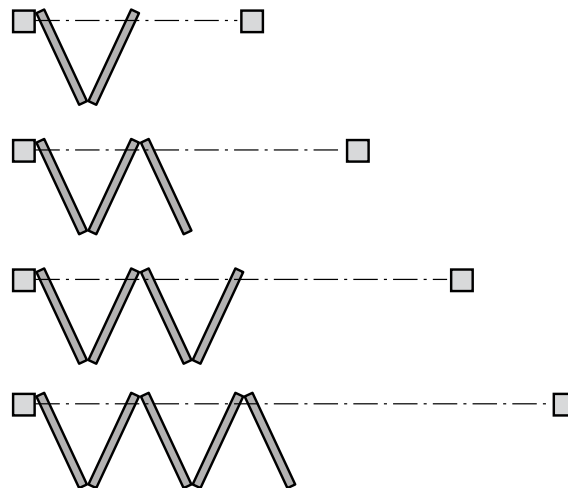

LITE FOLD

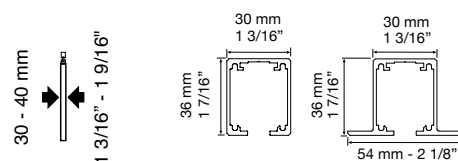

LITE FOLD 100 E

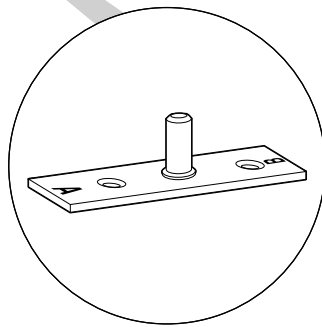

PIVOTE ESTÁNDAR A SUELO
STANDARD PIVOT TO THE FLOOR

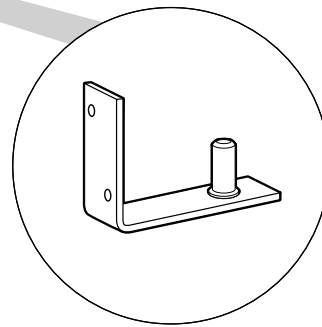

PIVOTE OPCIONAL A PARED
OPTIONAL PIVOT TO THE WALL

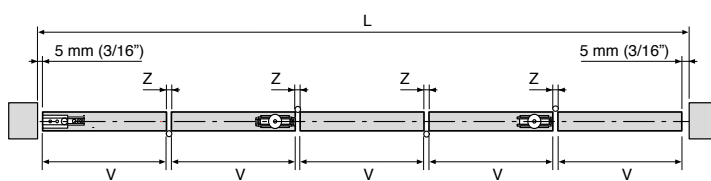

$$V = \frac{L - 10 \text{ mm } (3/8'') - ((N - 1) \times Z)}{N}$$

N = N° de hojas / Number of leaves

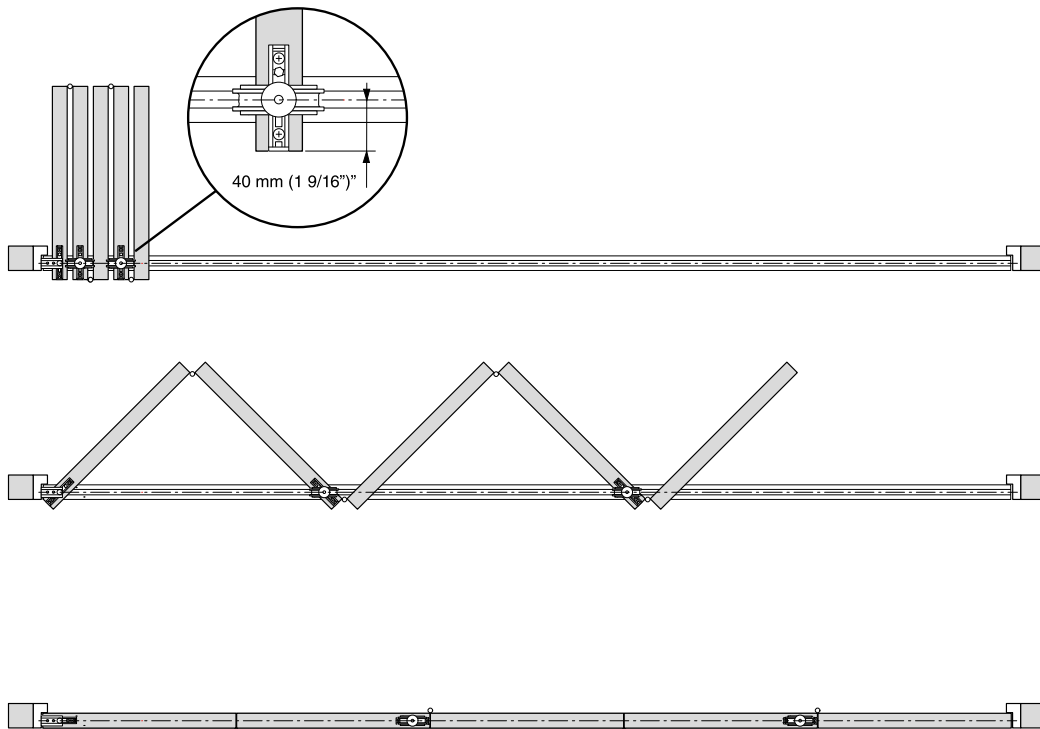
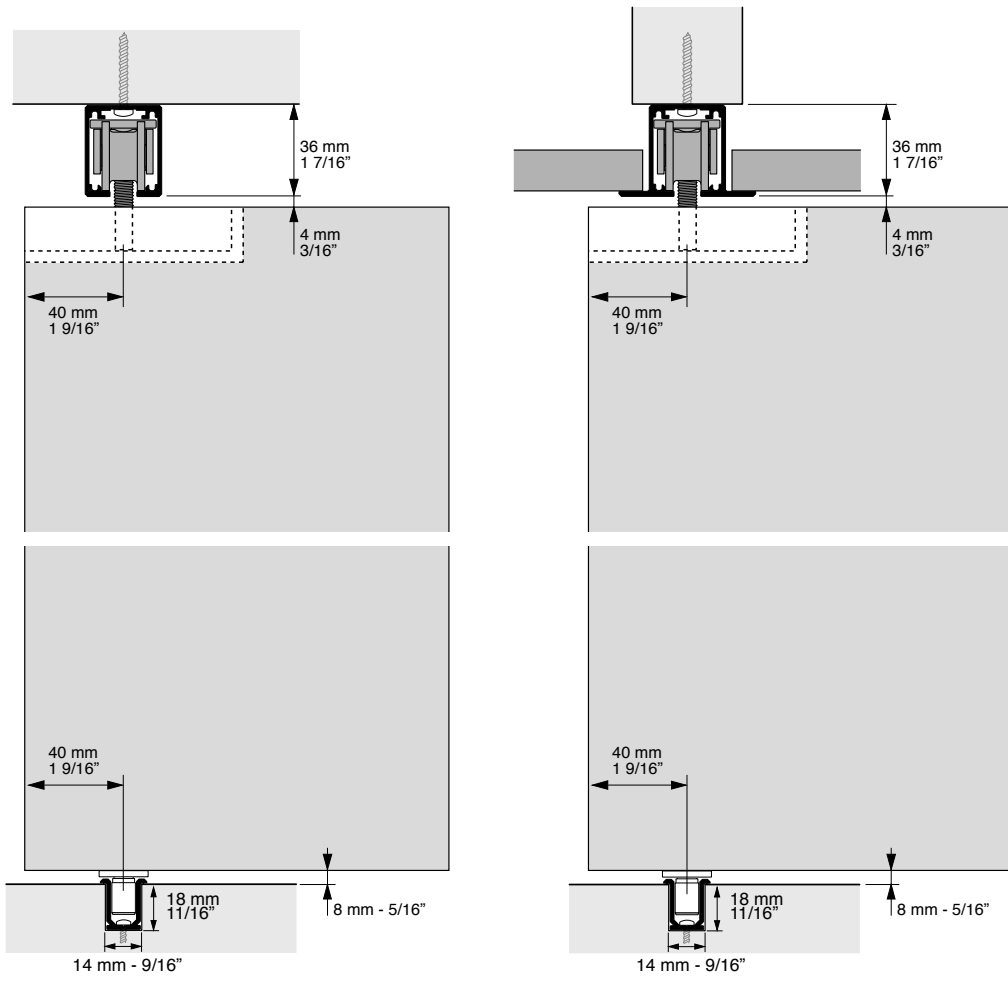

REFERENCIAS / REFERENCES / RÉFÉRENCES / REFERÈNCIES

ESP

LITE FOLD			
Ref.	Descripción	U.	Img.
2282	PFS. LITE FOLD 100 ALU. ANOD. SILV. 2m	1	A+C
2283	PFS. LITE FOLD 100 ALU. ANOD. SILV. 3m	1	A+C
2284	PFS. LITE FOLD 100 ALU. ANOD. SILV. 4m	1	A+C
2286	PFS. LITE FOLD 100 ALU. ANOD. SILV. 6m	1	A+C
2292	PFS. LITE FOLD 100 TOP ALU. ANOD. SILV. 2m	1	B+C
2293	PFS. LITE FOLD 100 TOP ALU. ANOD. SILV. 3m	1	B+C
2294	PFS. LITE FOLD 100 TOP ALU. ANOD. SILV. 4m	1	B+C
2296	PFS. LITE FOLD 100 TOP ALU. ANOD. SILV. 6m	1	B+C
2290	JGO. ACC. LITE FOLD 100 A	1	D
2145	JGO. ACC. LITE FOLD 100 B	1	E
2195	PIVOTE INF. PARED	1	F

ENG

LITE FOLD			
Ref.	Description	Units	Img.
2282	PFS. LITE FOLD 100 ALU. ANOD. SILV. 2m	1	A+C
2283	PFS. LITE FOLD 100 ALU. ANOD. SILV. 3m	1	A+C
2284	PFS. LITE FOLD 100 ALU. ANOD. SILV. 4m	1	A+C
2286	PFS. LITE FOLD 100 ALU. ANOD. SILV. 6m	1	A+C
2292	PFS. LITE FOLD 100 TOP ALU. ANOD. SILV. 2m	1	B+C
2293	PFS. LITE FOLD 100 TOP ALU. ANOD. SILV. 3m	1	B+C
2294	PFS. LITE FOLD 100 TOP ALU. ANOD. SILV. 4m	1	B+C
2296	PFS. LITE FOLD 100 TOP ALU. ANOD. SILV. 6m	1	B+C
2290	SET OF ACC. LITE FOLD 100 A	1	D
2145	SET OF ACC. LITE FOLD 100 B	1	E
2195	BOTTOM WALL PIVOT	1	F

FRA

LITE FOLD			
Ref.	Description	Unités	Img.
2282	PFS. LITE FOLD 100 ALU. ANOD. SILV. 2m	1	A+C
2283	PFS. LITE FOLD 100 ALU. ANOD. SILV. 3m	1	A+C
2284	PFS. LITE FOLD 100 ALU. ANOD. SILV. 4m	1	A+C
2286	PFS. LITE FOLD 100 ALU. ANOD. SILV. 6m	1	A+C
2292	PFS. LITE FOLD 100 TOP ALU. ANOD. SILV. 2m	1	B+C
2293	PFS. LITE FOLD 100 TOP ALU. ANOD. SILV. 3m	1	B+C
2294	PFS. LITE FOLD 100 TOP ALU. ANOD. SILV. 4m	1	B+C
2296	PFS. LITE FOLD 100 TOP ALU. ANOD. SILV. 6m	1	B+C
2290	JEU ACC. LITE FOLD 100 A	1	D
2145	JEU ACC. LITE FOLD 100 B	1	E
2195	PIVOTE INF. MURAL	1	F

CAT

LITE FOLD			
Ref.	Descripció	U.	Img.
2282	PFS. LITE FOLD 100 ALU. ANOD. SILV. 2m	1	A+C
2283	PFS. LITE FOLD 100 ALU. ANOD. SILV. 3m	1	A+C
2284	PFS. LITE FOLD 100 ALU. ANOD. SILV. 4m	1	A+C
2286	PFS. LITE FOLD 100 ALU. ANOD. SILV. 6m	1	A+C
2292	PFS. LITE FOLD 100 TOP ALU. ANOD. SILV. 2m	1	B+C
2293	PFS. LITE FOLD 100 TOP ALU. ANOD. SILV. 3m	1	B+C
2294	PFS. LITE FOLD 100 TOP ALU. ANOD. SILV. 4m	1	B+C
2296	PFS. LITE FOLD 100 TOP ALU. ANOD. SILV. 6m	1	B+C
2290	JOC ACC. LITE FOLD 100 A	1	D
2145	JOC ACC. LITE FOLD 100 B	1	E
2195	PIVOTE INF. PARET	1	F

2 HOJAS
2 LEAVES



JGO. ACC. **A**
SET ACC. **A**

4 HOJAS
4 LEAVES



JGO. ACC. **A+B**
SET ACC. **A+B**

3 HOJAS
3 LEAVES



JGO. ACC. **A**
SET ACC. **A**

5 HOJAS
5 LEAVES



JGO. ACC. **A+B**
SET ACC. **A+B**



A



B



C



D

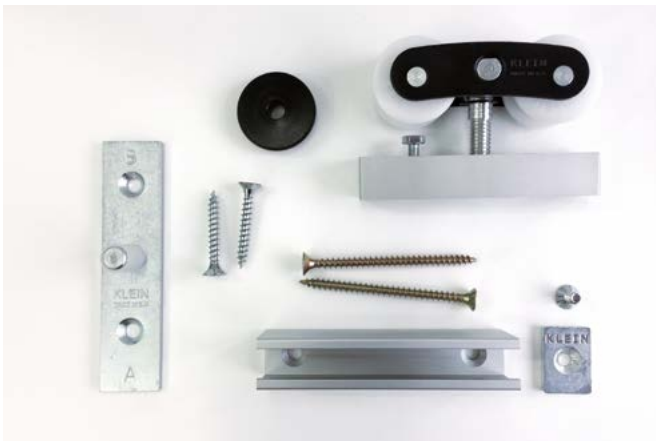

E



F

KLEIN®

KLEIN EUROPE
Edificio KLEIN
Polígono Industrial Can Cuyás
N-150 Km. 1
08110 Montcada i Reixac
Barcelona (Spain)

Tel.: +34 935 760 101
Fax: +34 935 760 109

+Info
klein@klein.es
www.klein.es

Síguenos en redes
Follow us on social media

